

2019



	Elektrokoagulátory		2
	Elektrochirurgické príslušenstvo		10
	Laparoskopia		24
	Artroskopia		57
	Operačné lampy		64
	Operačné stoly		66
	Pulzné oximetre		72
	SpO ₂ senzory, EKG káble, NIBP manžety		74
	Odsávačky		85

Medpin

Čistiaca pištoľ komplet s 9 adaptérmi	707-600	
Čistiaca kefka, dĺžka 480 mm	pre rúry Ø	bal 10 kusov
	3 mm	707-604
	5 mm	707-605
	10 mm	707-610
Sterilizačný stojan na laparoskopické inštrumenty (bez drôteného koša)	87295-00	
Drôtený kôš pre 87295-00 (510 x 255 x 50 mm)	87015-20	
Kontajner pre 87295-00	87200-1F-SI	
Sterilizačná kazeta pre 2 optiky, rôzne farby	250 x 60 x 50 mm 450 x 70 x 70 mm	87280-2F 87290-2F

Drôtený kôš pre optiky > Ø 2.7 mm	460 x 80 x 52 mm 290 x 80 x 52 mm	707-650 707-651
Autoklávovateľné ochranné hadičky pre optiky do priemeru Ø 5 mm, spojenie dvoch hadičiek umožňuje ochranu urologických a gynekologických optík	700-999	
Špeciálny olejový sprej na údržbu chirurgických inštrumentov. Neobsahuje silikón. Zabraňuje hrdzaveniu, skraca čas čistenia. Je fyziologicky nezávadný, používa sa pred sterilizáciou.		95000-00
Silikónové tesnenie		95010-00
Uzáver LL plastový, biely		95011-00
Uzáver LL plastový, čierny		95011-02
Uzáver LL, nerez		95012-00

Roztok proti zahmlievaniu	Prepichovacia fľaša sterilná	Pipetová fľaša	Sprej
	30 ml	25 ml	15 ml
	95000-50	95000-51	95000-52

MOBI Power Tools



Tekno Mobi je komplexný motorový systém pre ortopédiu a traumatológiu. Dostupný je v rôznych konfiguráciách. Všetky modely sú vybavené rýchlopúšiacim konektorom zaručujúcim jednoduchú a rýchlu výmenu inštrumentov. Systém je navrhnutý s dôrazom na jednoduchú obsluhu a dlhú životnosť. Napájaný je z lítium-iónového akumulátora bez pamätového efektu.

 MOBI DM • Univerzálna vŕtačka / fréza • 0 - 1000 ot/min	 MOBI R • Pílka na sternum • 0 - 7500 ot/min (stupeň I) • 0 - 10000 ot/min (stupeň II)
 MOBI D • Vŕtačka • 0 - 1000 ot/min (vŕtanie) • 0 - 250 ot/min (frézovanie)	 MOBI RS • Vratná píla • 0 - 7500 ot/min (stupeň I) • 0 - 10000 ot/min (stupeň II)
 MOBI O • Oscilačná píla • 0 - 9000 ot/min (stupeň I) • 0 - 11000 ot/min (stupeň II)	 PowerPack • Li-Ion • Indikácia kapacity • osvetlenie počas aktivácie

Shaver system TM920



- Pre zákroky na malých aj veľkých kĺboch
- Smer a rýchlosť rotácie sa dá ovládať tlačidlami alebo pedálom
- Tichý a hladký chod, vysoká kapacita odsávania
- Dizajn inštrumentu znižuje únavu ruky pri práci
- Inštrument je autoklávovateľný
- Vodotesný pedál s protišmykovým povrchom
- Úplné ovládanie pedálom, jednoduchá obsluha

Artroskopické optiky

Ø (mm)	Pracovná dĺžka (mm)	0°	30°	45°	70°		
2.7	110	700-100	700-103		700-107		
2.7	175	700-110	700-113		700-117		
2.7	187.5	700-120	700-123		700-127		
4.0	175	700-130	700-133	700-134	700-137		
2.7	110	700-100SF	700-103SF				
2.7	175	700-110SF	700-113SF				
2.7	187.5	700-120SF	700-123SF				
4.0	175	700-130SF	700-133SF	700-134SF	700-137SF		

SF = Semiflexibilné optiky TeknoFlex

Mini - Artroskopické optiky

Ø (mm)	Pracovná dĺžka (mm)	0°	15°	30°		
1.7	58	700-160	700-165			
1.7	104	700-170	700-175			
1.9	69	700-196		700-198		
1.9	102	700-197		700-199		
2.0	58	700-180	700-185			
2.0	104	700-190	700-195			

Artroskopické rúry a obturátory

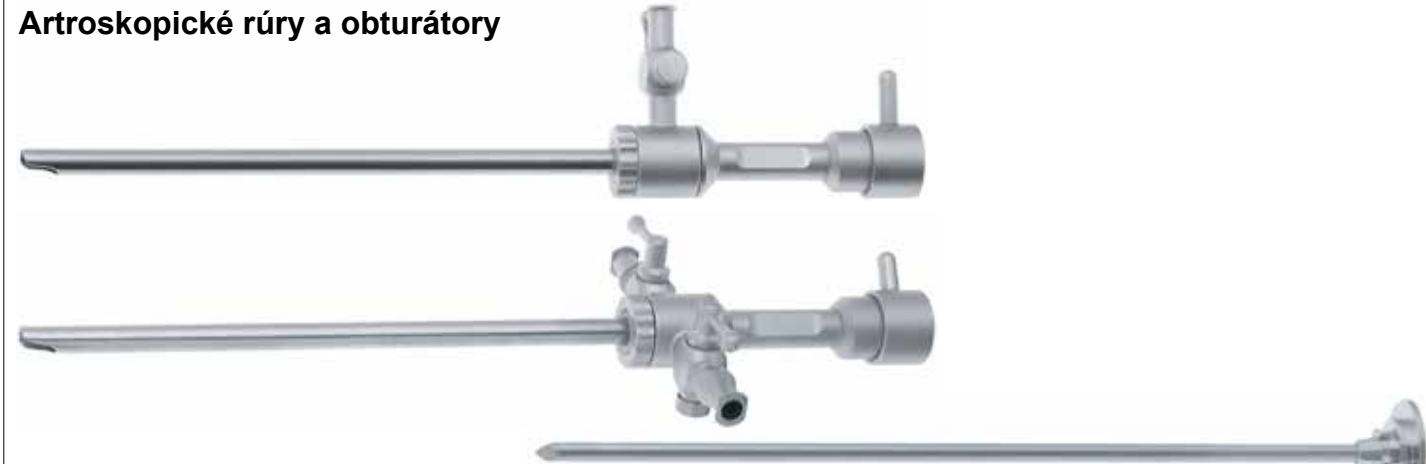

Vonkajší Ø (mm)	Pre optiku		Pracovná dĺžka (mm)	Rúra s ventilmi rigidna		Rúra s ventilmi otočná		Obturátor	
	Ø (mm)	uhol		1 ventil	2 ventily	1 ventil	2 ventily	špicatý	zaoblený
4.0	2.7	0°	175.0	39110-01	39111-01	39112-01	39113-01	39101-01	39100-01
4.0	2.7	0°	110.0	39110-02	39111-02	39112-02	39113-02	39101-02	39100-02
4.0	2.7	0°	187.5	39110-03	39111-03	39112-03	39113-03	39101-03	39100-03
5.5	4.0	0°	175.0	39110-04	39111-04	39112-04	39113-04	39101-04	39100-04
6.5	4.0	0°	175.0				39113-05	39101-05	39100-05
4.0	2.7	30°	175.0	39114-01	39116-01	39115-01	39117-01	39101-01	39100-01
4.0	2.7	30°	110.0	39114-02	39116-02	39115-02	39117-02	39101-02	39100-02
4.0	2.7	30°	187.5	39114-03	39116-03	39115-03	39117-03	39101-03	39100-03
5.5	4.0	30°	175.0	39114-04	39116-04	39115-04	39117-04	39101-04	39100-04

Mini - Artroskopické rúry a obturátory

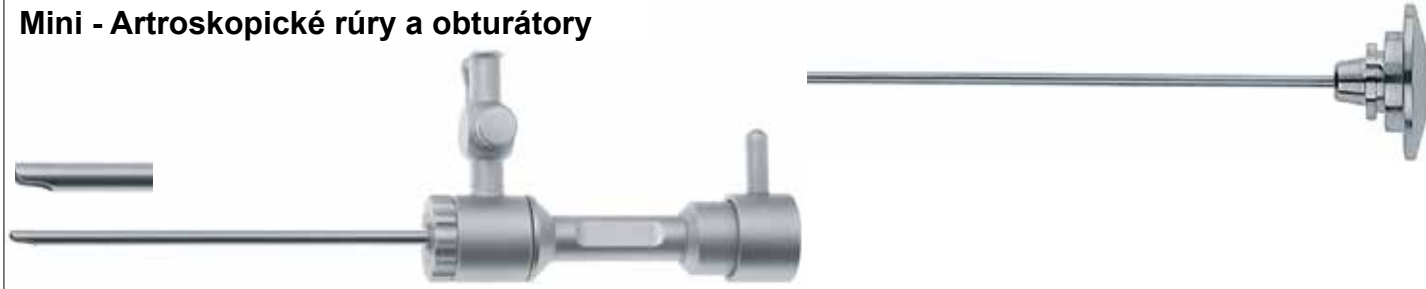

Vonkajší Ø (mm)	Pre optiku Ø (mm)	Pracovná dĺžka (mm)	Rúra s ventilmi otočná		Obturátor	
			1 ventil	2 ventily	špicatý	zaoblený
2.5	1.7	58	39205-00	39205-02	39201-10	39201-00
2.5	1.7	104	39205-01	39205-03	39201-11	39202-00
2.5	2.0	58	39205-10	39205-12	39202-10	39201-01
2.5	2.0	104	39205-11	39205-13	39202-11	39202-01

Irigačné kanyly



Ostrekovacia kanyla s ventilom a LL-konektorom, komplet s ostrým bodcom a obľým obturátorom	Ø (mm)	Kat.č.	Kanyla s ventilom a LL-konektorom	Ø (mm)	Kat.č.
		3.2		39170-01	
	4.5	39170-02		4.5	39172-02



Bodec ostrý	Ø (mm)	Kat.č.	Obturátor obľý	Ø (mm)	Kat.č.
		3.2		39175-01	
	4.5	39175-02		4.5	39178-02

Shaver čepele

Ø (mm)	Trimmer	Plnorádiusový resektor	Agresívny plnorádiusový resektor	Meniskus cutter	Agresívny meniskus cutter	Okrúhla fréza	Kuželová fréza	Oválna fréza
--------	---------	------------------------	----------------------------------	-----------------	---------------------------	---------------	----------------	--------------



Pre shavery Tekno-Medical, Linvatec/Concept, Artrex a Friatec, kovová spojka, autoklávoateľné, balenie 5 ks

2.5	39820-203	39820-233	39820-213	39820-223	39820-205			
3.5	39820-603	39820-630	39820-610	39820-620	39820-605			
4.2	39820-703	39820-730	39820-710	39820-720	39820-705	39820-760		
5.5	39820-803	39820-830	39820-810	39820-820	39820-805	39820-860	39820-870	39820-880

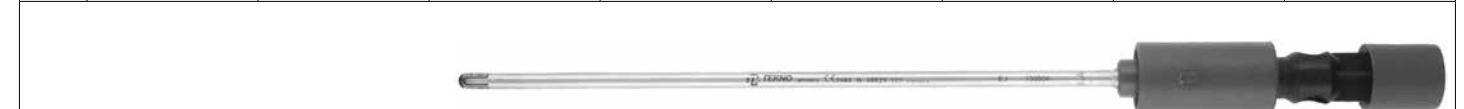

Pre shavery Tekno-Medical, Linvatec/Concept, Artrex a Friatec, plastová spojka, autoklávoateľné, balenie 5 ks

2.5	39820-201	39820-230	39820-210	39820-220	39820-204			
3.5	39820-301	39820-330	39820-310	39820-320	39820-304			
4.2	39820-401	39820-430	39820-410	39820-420	39820-404			
5.5	39820-501	39820-530	39820-510	39820-520	39820-504	39820-560	39820-570	39820-580



Pre shavery Tekno-Medical, Linvatec/Concept, Artrex a Friatec, plastová spojka, sterilné, jednorazové, balenie 5 ks

2.5	39820-201S	39820-230S	39820-210S	39820-220S	39820-204S			
3.5	39820-301S	39820-330S	39820-310S	39820-320S	39820-304S			
4.2	39820-401S	39820-430S	39820-410S	39820-420S	39820-404S			
5.5	39820-501S	39820-530S	39820-510S	39820-520S	39820-504S	39820-560S	39820-570S	39820-580S



Pre shavery Dyonics PS3500 a PS3500EP, plastová spojka, autoklávoateľné, balenie 5 ks

3.5		39821-330	39821-310	39821-320				
4.2		39821-430	39821-410	39821-420				
5.5		39821-530	39821-510	39821-520		39821-560	39821-570	39821-580



Pre shavery Dyonics EP1, kovová spojka, autoklávoateľné, balenie 5 ks

3.5		39822-330	39822-310	39822-320	39822-340			
4.2	39822-450	39822-430	39822-410	39822-420	39822-440			
5.5		39822-530	39822-510	39822-520	39822-540	39822-560	39822-570	39822-580



Pre shavery Stryker, kovová spojka, autoklávoateľné, balenie 5 ks

3.5		39823-330	39823-310	39823-320	39823-340			
4.2	39823-450	39823-430	39823-410	39823-420	39823-440			
5.5		39823-530	39823-510	39823-520	39823-540	39823-560	39823-570	39823-580

Artroskopické punche

		Ø (mm)	Hákový nožnice	Hákový punch s lyžicou	Hákový punch oblý	Hákový punch štikací
priamy		2.7	39651-01	39653-01	39654-01	39655-01
		3.5	39651-02	39653-02	39654-02	39655-02
30° vpravo		2.7	39651-03	39653-03	39654-03	39655-03
		3.5	39651-04	39653-04	39654-04	39655-04
30° vľavo		2.7	39651-05	39653-05	39654-05	39655-05
		3.5	39651-06	39653-06	39654-06	39655-06
45° vpravo		2.7	39651-07	39653-07	39654-07	39655-07
		3.5	39651-08	39653-08	39654-08	39655-08
45° vľavo		2.7	39651-09	39653-09	39654-09	39655-09
		3.5	39651-10	39653-10	39654-10	39655-10
15° nahor		2.7	39651-15	39653-15	39654-15	39655-15
		3.5	39651-16	39653-16	39654-16	39655-16
15° nadol		2.7	39651-17	39653-17	39654-17	39655-17
		3.5	39651-18	39653-18	39654-18	39655-18

- Špičková kvalita rezu
- Komfortná rukoväť
- Možnosť dodať inštrument aj s pružinou

		Ø (mm)	šírka 5.0 mm	šírka 3.5 mm	šírka 2.5 mm
priamy		3.5	39680-01	39681-01	39682-01
30° vpravo		3.5	39680-02	39681-02	39682-02
30° vľavo		3.5	39680-03	39681-03	39682-03
30° vpravo 15° nahor		3.5	39680-04	39681-04	39682-04
30° vľavo 15° nahor		3.5	39680-05	39681-05	39682-05
15° nahor		3.5	39680-06	39681-06	39682-06
priamy		3.5	39687-02	39688-02	39689-02

Čeluste priame

Čeluste 15° nahor

Čeluste 15° nahor					
		Ø (mm)	bez naberačky		
15° nahor		2.7	39657-03		
15° nahor		3.5	39657-04		

Priame čeluste					
		Ø (mm)	Bez naberačky	S naberačkou	
45° vpravo		3.5	39658-04	39658-02	
45° vľavo		3.5	39659-04	39659-02	
90° vpravo		3.5	39660-04	39660-02	
90° vľavo		3.5	39661-04	39661-02	

Artroskopický punch retrográdný

Ø (mm)	Strih vpravo	Strih vľavo
3.5	39650-01	39650-02

Artroskopické punche

	Mierka 1:1	x (mm)			
Cushing 2 mm x 10 mm		130	28030-13	28031-13	28033-13
		180	28030-18	28031-18	28033-18
		220	28030-22	28031-22	28033-22
Love-Gruenwald 3 mm x 10 mm		130	28034-13	28035-13	28037-13
		180	28034-18	28035-18	28037-18
		220	28034-22	28035-22	28037-22
Spurling 4 mm x 10 mm		130	28038-13	28039-13	28041-13
		180	28038-18	28039-18	28041-18
		220	28038-22	28039-22	28041-22
Cloward 6 mm x 10 mm		180	28042-18		

Artroskopické punche

	Ø (mm)	Grasper	Grasper	Grasper 1 x 2	Grasper 1 x 2
Bez aretácie	2.7	-	39670-01	-	-
	3.5	39674-02	39670-02	39671-02	39673-02
S aretáciou	2.7	-	39670-03	-	-
	3.5	39674-04	39670-04	39671-04	39673-04

Artroskopický grasper

Posuvné tiahlo, 1 x 2 zuby, priamy, s aretáciou, dĺžka 205 mm | 39650-20

Artroskopické inštrumenty ručné



Rukoväť pre inštrumenty 39600-xx 39600-00

	Kompletný inštrument	Vložka do rukoväte 39600-00
	Meniskotom Smillie, 7 mm	39599-01 39600-01
	Skalpelový nôž	39599-02 39600-02
	Ružicový nôž, zahnutý o 30° doľava, zúbkovaný	39599-03 39600-03
	Ružicový nôž, zahnutý o 30° doprava, zúbkovaný	39599-04 39600-04
	Ružicový nôž, priamy, zúbkovaný	39599-05 39600-05
	Kosákovitý nôž	39599-06 39600-06
	Háková sonda a retraktor, špicatá	39599-07 39600-07
	Nôž, zahnutý 45°	39599-08 39600-08
	Bajonetový nôž	39599-09 39600-09
	Banánový nôž, zúbkovaný	39599-10 39600-10
	Banánový nôž, hladký	39599-11 39600-11
	Lýžica, Ø 3 mm, zahnutá 45°	39599-12 39600-12
	Háková sonda, ciachovaná, 3 mm	39599-14 39600-14
	Háková sonda, ciachovaná, 5 mm	39599-15 39600-15
	Kruhovú kyretu Ø 7 mm, zahnutá 15°	39599-16 39600-16
	Kruhovú kyretu Ø 3 mm, zahnutá 15°	39599-17 39600-17
	Hákový nôž, Ø 3 mm, 90°, laterálny rez	39599-18 39600-18
	Hákový nôž, Ø 5 mm, 90°, laterálny rez	39599-20 -
	Meniskotom Smillie, šírka 3 mm	39599-19S 39600-19S
	Meniskotom Smillie, šírka 5 mm	39599-19W 39600-19W

Artroskopické inštrumenty ručné

	39600-20 Skalpel		39600-24 Meniskotom		39600-28 Rozetový nôž, zúbkovaný
	39600-21 Háková sonda 4.0 mm		39600-25 Hákový nôž, 90°		39600-29 Banánový nôž, zúbkovaný
	39600-22 Banánový nôž		39600-26 Lýžica, zahnutá 30°, Ø 3.0 mm		39600-30 Prstencová kyreta, zahnutá 30°, Ø 3.0 mm
	39600-23 Nôž 45°		39600-27 Smillie meniskotom, Ø 3.0 mm		

Monopolárne artroskopické elektródy

	Ø 4 mm		Ø 4 mm	
	Ihlová elektróda zahnutá o 90°, Ø 1.5 mm, špička 0.6 mm, dĺžka 115 mm	580-210	Elektróda okrúhla s priehlbinou, dĺžka 115 mm	580-280
	Ihlová elektróda zahnutá o 90°, Ø 4 mm, špička 0.6 mm, dĺžka 115 mm	580-220	Elektróda okrúhla plochá, dĺžka 115 mm	580-290
	Nožová elektróda zahnutá o 45°, Ø 3 mm, špička 0.4 mm, dĺžka 115 mm	580-240	Elektróda okrúhla vrúbkovaná, dĺžka 115 mm	580-260
	Elektróda zahnutá o 90°, Ø 3 mm, špička 1.5 mm, dĺžka 115 mm	580-250	Elektróda guľová priama, dĺžka 115 mm	580-270

Káble pre monopolárne artroskopické elektródy sú na strane 12 - tabuľka hore.

Bipolárne artroskopické elektródy

		Konektor pre bipolárny kábel	Integrovaný kábel SDS 3m
	Ihlová elektróda zahnutá o 90°, Ø 1.5 mm, špička 0.6 x 1.5 mm, na rezanie	dĺžka 115 mm dĺžka 170 mm	587-010 587-030 58S-010 58S-030
	Ihlová elektróda zahnutá o 90°, Ø 4 mm, špička 0.6 x 4 mm, na rezanie	dĺžka 115 mm dĺžka 170 mm	587-020 587-060 58S-020 58S-060
	Elektróda zahnutá o 90°, Ø 4 mm, špička 1.5 x 4 mm, na rezanie a vaporizáciu	dĺžka 115 mm	587-040 58S-040
	Slučková elektróda COBRA, na rezanie a vaporizáciu	dĺžka 115 mm dĺžka 170 mm	587-090 587-011 58S-090 58S-011
	Elektróda PHAZER zahnutá o 70°, Ø 2.4 mm, na vaporizáciu	dĺžka 115 mm dĺžka 170 mm	587-110 587-140 58S-110 58S-140
	Elektróda VAP na vaporizáciu	dĺžka 115 mm dĺžka 170 mm	587-160 587-170 58S-160 58S-170
	Guľová elektróda, Ø 2.4 mm	dĺžka 115 mm	587-070 58S-070
	Elektróda VAP okrúhla na vaporizáciu	dĺžka 170 mm	587-920 58S-920

nové

Káble pre bipolárne artroskopické elektródy sú na strane 13 - tabuľka hore. Elektródy SDS majú integrovaný kábel 3m.

Medpin

Medpin s.r.o.
Opálová 18
851 10 Bratislava



E-mail: medpin@medpin.sk
www.medpin.sk

Peter Ondačka 0907-729 243
Ing. Igor Malinarič 0907-728 744

